



TRANSPORT PACKAGING SOLUTIONS



# Edgeboard

Protection, stability and stacking strength

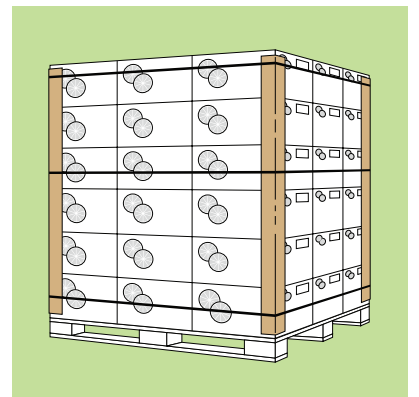
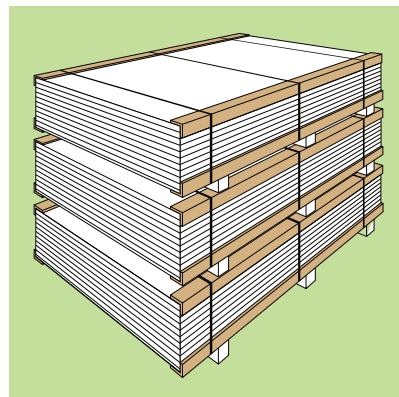
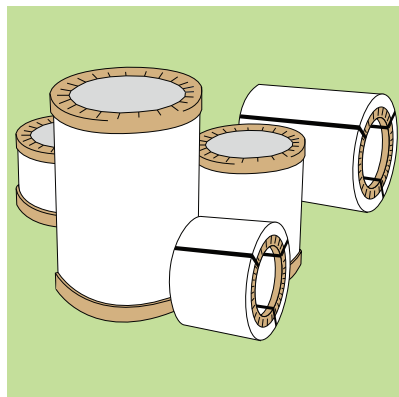
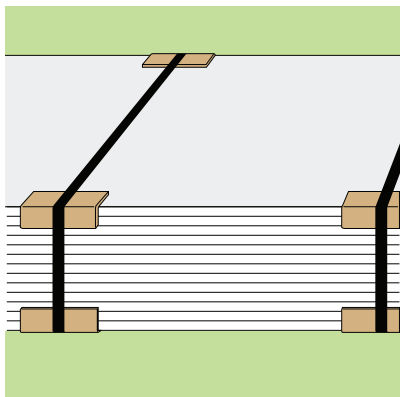
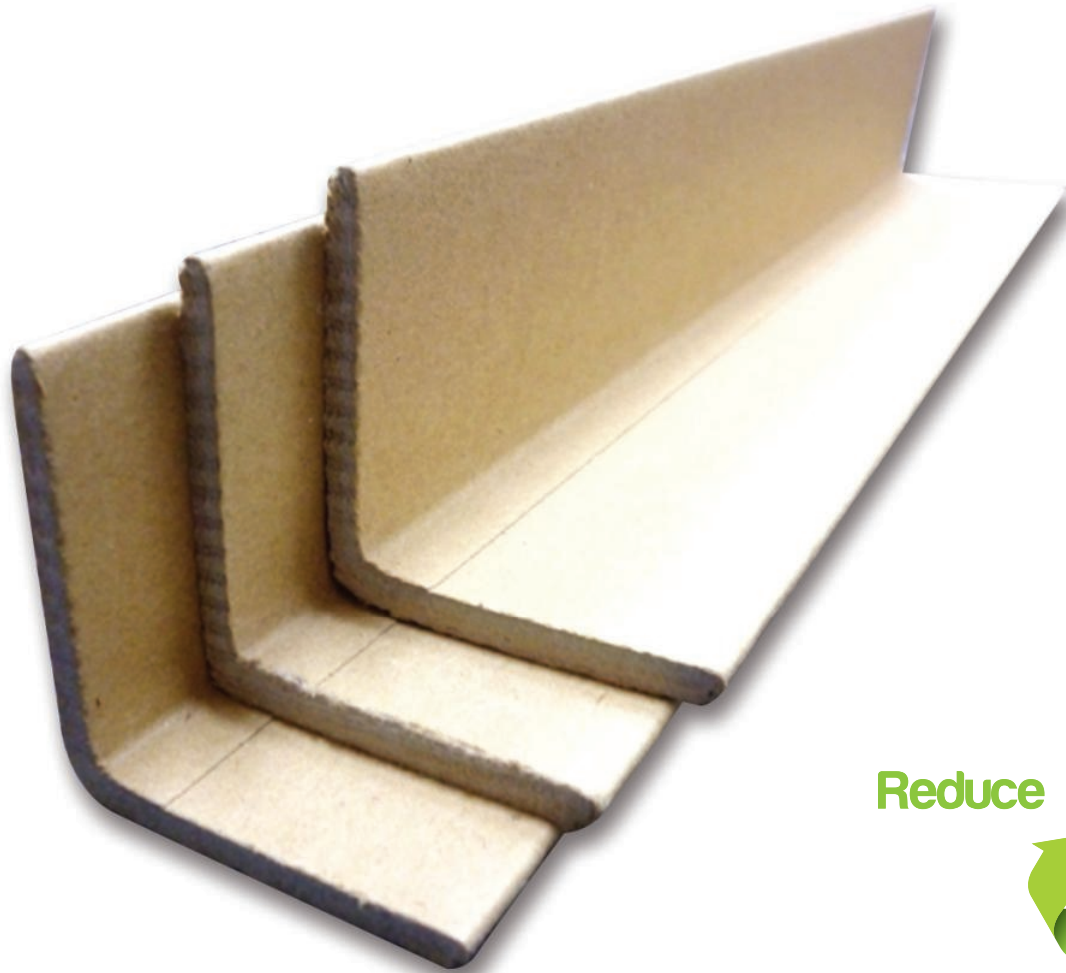

Sustainable packaging is your contribution to the environment



## EDGEBOARD IS AN EXCELLENT PRODUCT BECAUSE

- It's cheap, recyclable,

Damage caused during transport and handling is a problem for manufacturers and distributors. This is why a number of producers and packaging experts have chosen compact edge protection as a solution.

Eltete can offer a complete system to solve your packaging problems. Edgeboards, U-profiles, Flatboards, Carton Board Pallets, PallRuns® and Slip Sheets in combination with stretch foil, shrink wrap and strapping guarantee that you will find an optimal solution for every product.

In this way Eltete has profiled its concept, which we and our partners would like to share with all our customers.

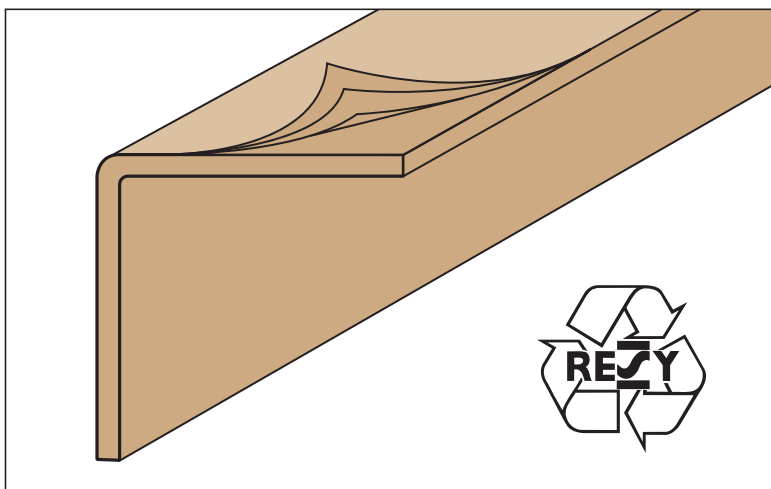
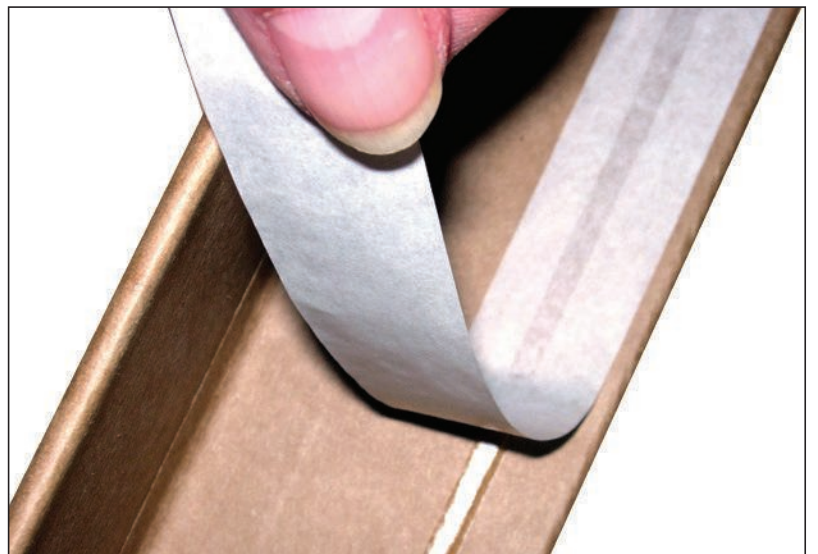

*Raw Material. The standard edgeboard is manufactured by laminating several layers of strong paperboard.*

### ECONOMY AND COST SAVINGS

By using edgeboard, we aim to offer the customer a measurable advantage.

Our packaging solution with edgeboard

- replaces expensive packaging material
- saves work and material
- is environmentally friendly
- is suitable for food packaging and can be sent all over the world without any need of extra treatment, such as the fumigation required for wooden material
- allows you to optimize your transport space by double-stacking
- strengthens your package and minimizes transport damage

# ation to the Environment

## BECAUSE OF ITS FLEXIBILITY IN PACKAGING.

, easy to use yet strong -

### VERTICAL PROTECTION

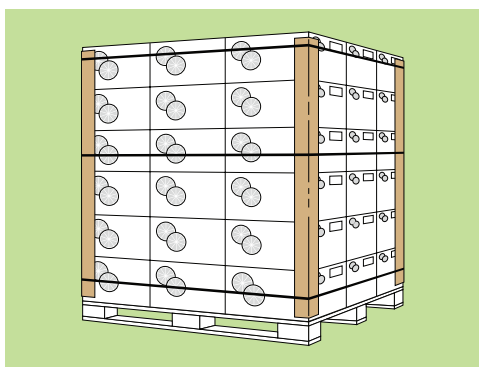

Edgeboards stabilise the pallets and provide protection during transport and warehousing.

### STRENGTHENING PACKAGING UNITS

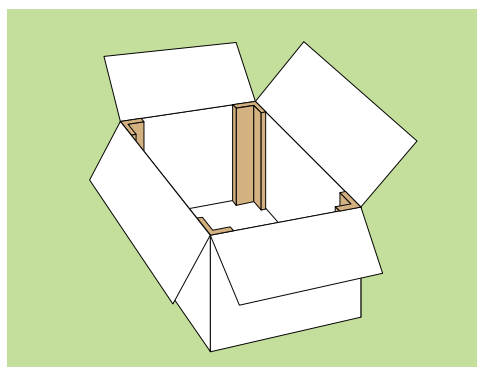

The strength of a single package can be improved by reinforcing boxes internally with edgeboards.

### ROUND C-PROFILES

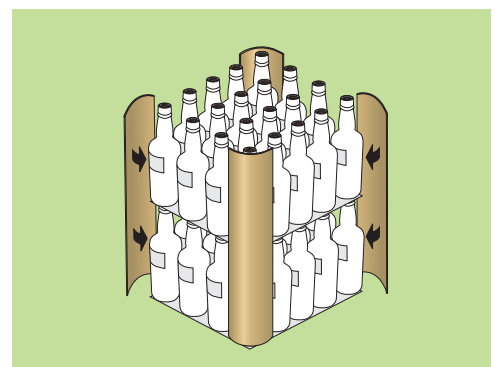

Use C-profiles for round corners.

### PROTECTION OF EDGES

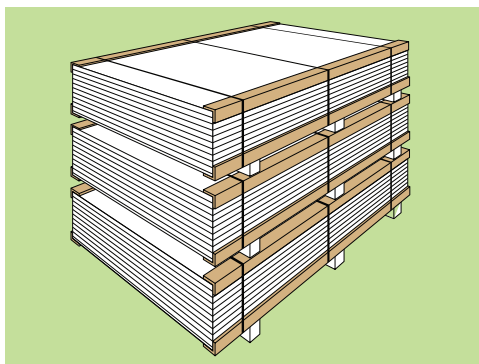

Edgeboards protect and support products during all handling operations.

### U-PROFILE

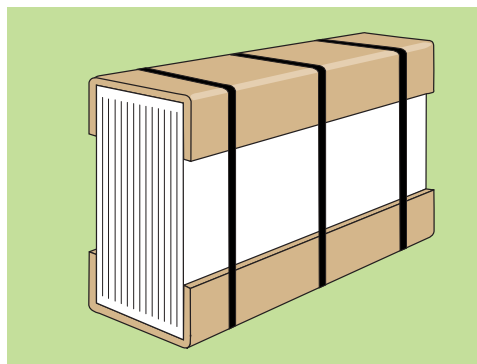

U-profiles are manufactured precisely to meet customer needs.

### SELF-ADHESIVE

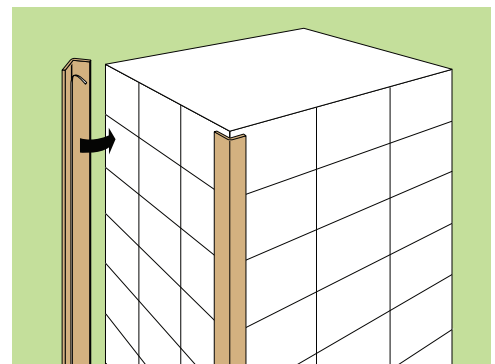

The use of self-adhesive edgeboard improves handling before final strapping is applied.

### STACKING STRENGTH

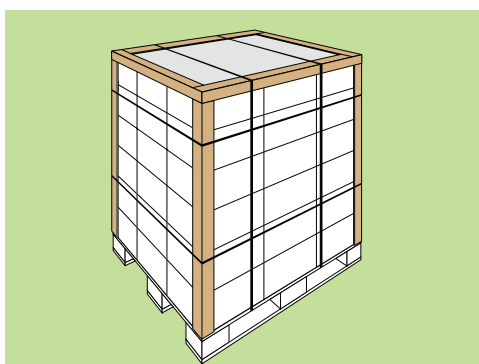

Choosing the right edgeboards for strengthening units will enable you to optimise space by doublestacking.

### STRAPPING PROTECTION

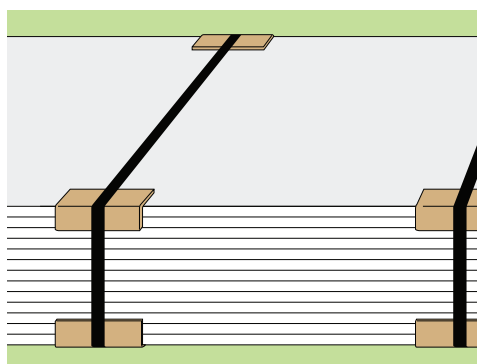

Protecting the product against strapping damage.

### WRAP-AROUND EDGEBOARD

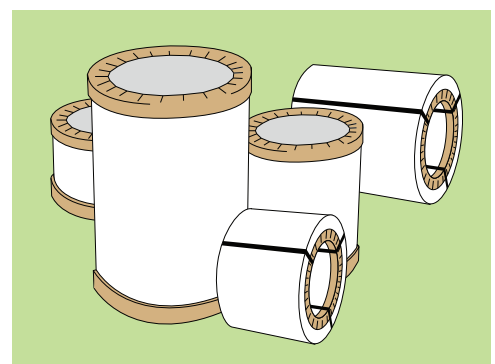

The flexible wrap-around edgeboard is easy to use for inside or outside protection.

## EDGEBOARD SIZES

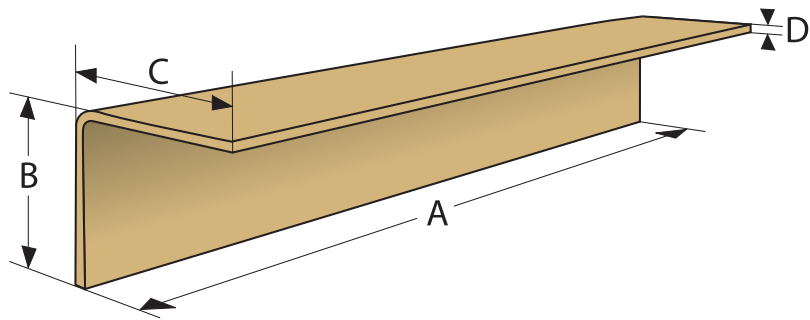

## STANDARD SIZES

A mm	B mm	C mm	D mm
50-4000	30	30	2 - 7
	35	35	
	40	40	
	50	50	2 - 8
	60	60	
	70	70	
	80	80	
100	100		

## QUALITIES

Edgeboard can be delivered in Bio quality. A variety of surfaces are available in brown, white or colour.

## COLD LAMINATION (BIO)

Laminated with a water-soluble glue under high pressure. The selected raw materials are all of high quality and 100% recyclable. Ask for more information about humisafe qualities.

## OPTIONS

- Self-adhesive Add & Stick edgeboards
- Wrap-around edgeboards for round objects
- C-profiles
- Edgeboards with soft foam

Ask for more information.

## PRINTING

Company names, logos and advertisements can easily be printed during the manufacturing process.

## STRENGTH

To find the right product for your purposes, we can test the strapping strength, compression, bending, tear resistance.



## NEW POSSIBILITIES

### EdgeRunner®



A combination of edgeboards and PallRuns®, is a new 4-way pallet alternative. It will optimise the space need; you will load more and get all the benefits of a strong sustainable packaging.

### EdgePall



A cartonboard pallet made of PallRun®, flatboard and edgeboards. Edgeboard gives protection against forklift forks and ensures that goods always arrive at their destination undamaged.

Eltete TPM Ltd (Transport Packaging Materials) is a global carton board converter and an ISO-certified supplier of 100 % recyclable transport packaging materials. With own engineering division we are able to react quickly to customer demands.

With experience since 1974, we are experts on the needs of today's market. Innovative and high-quality packaging solutions made of compact carton board are being offered in more than 60 countries through Eltete sales organization. With 22 production sites in 15 countries we are close to our customers.

Eltete TPM is the world's leading producer of sustainable carton board transport packaging materials and solutions in the world.

### Eltete Malaysia Sdn Bhd

No. 46 & 48, Jalan TPP 5, Taman Perindustrian Putra, 47130 Puchong, Selangor Darul Ehsan, Malaysia  
Tel: +6(03) 8069 1354 / 1357 Fax: +6(03) 8069 1358  
[www.eltete.com.my](http://www.eltete.com.my)

### Eltete (Vietnam) Co.,Ltd (Subsidiary of Eltete Malaysia Sdn Bhd)

Lot 3, Binh Duong Industrial Park, An Binh Ward Di An Town, Binh Duong Province, Vietnam  
Tel: +84 274 3 793530 Fax: + 84 274 3 793528  
[www.eltete.com.vn](http://www.eltete.com.vn)